

BDB



The burden of the
entire city...



CONTENTS

About Us	1 - 7	Recycling Bins	34 - 43
Galvanized Garbage Container	8 - 17	Rubble Containers	44 - 47
Above Ground Garbage Container	18 - 21	Truck Beds	48 - 49
Garden Type Garbage Container	22 - 29	Options	50
Benches	30 - 33	Certificates	52



Visionary, Innovative and Pioneer



Trustworthy, Transparent



Collaborative



Indigenous



Value-Creating For Society



Honest, Diligent and Responsible

About Us

BDB Metal, a leading company in this industry in Turkey, produces and markets metal waste containers, excavation containers, and recycling bins in various sizes at its factories in Istanbul and Ankara. Serving numerous municipalities, hospitals, universities, public institutions, and recycling companies within Turkey, BDB Metal also exports to several countries abroad, including Lithuania, Azerbaijan, Bulgaria, Georgia, Kosovo, Romania, Morocco, and Algeria. With 15 years of industry experience, BDB Metal upholds the highest quality standards through environmentally responsible production. The company focuses on designing and manufacturing waste containers that fit the recycling and waste collection systems of municipalities and institutions. Our factory, equipped with a skilled technical team and advanced technology, manages all quality processes from order to delivery, ensuring high-quality products for our clients. Guided by a vision of innovation and progress, BDB Metal is recognized as a reference point for both public institutions and the private sector in the field of urban cleanliness. Our facilities, with 12,000 m² of indoor space and 8,000 m² of outdoor space, and equipped with laser and plasma cutting and press brake machines, have a production capacity of up to 12,000 units per month in various product categories, serving customers both domestically and internationally.

We Care About Our Environment



As BDB Metal, we now offer comprehensive solutions for your management and cleaning needs.



By offering high-quality products to our customers, we contribute to a sustainable future.



Environmental health and order are our priorities. Waste management and recycling not only contribute to the environment and society but are also crucial for maintaining health standards.



Waste management needs continuously arise. Therefore, we are always ready to be by our customers' side and provide swift solutions whenever they need them.



Our product range includes various waste containers and waste management equipment. Our goal is to provide a clean and orderly environment for the community through our products.



At BDB Metal, we have an experienced and expert team. We work with a professional staff to deliver high-quality service to our customers. We are here to meet your waste container and waste management needs.



To provide our customers with the best service, we offer waste containers and waste management equipment made from high-quality and durable materials. With our expert team, we deliver customized solutions by considering customer needs. Additionally, we ensure customer satisfaction through prompt delivery and reliable customer support.



Strong metal structures ensure long-lasting use.



As an experienced and expert team, we prioritize customer satisfaction.



We value your time with our fast production and delivery processes.



Our products are manufactured and inspected in accordance with the highest quality standards.



By using recyclable materials, we make a positive impact on the environment.



We offer customization options based on customer requests and project requirements.

We are pleased to offer the most suitable waste container solutions to ensure a clean and orderly environment. Our expert team is here to provide you with the best service!

We Are Here

BDB



The burden of the entire city...



info@bdbmetal.com

444 7 909

Main Building

Bahçelievler Mah.
570. Cadde, No: 13
Hasanoğlan /
Elmadağ / ANKARA

Second Factory

Bahçelievler Mah.
599. Cadde, No: 18
Hasanoğlan /
Elmadağ / ANKARA

Marmara Office

Beylikdüzü OSB Mah.,
Birlik Sanayi Sitesi,
3. Cadde No:139
Beylikdüzü/İSTANBUL



We Support Waste Management in Municipalities!

In modern urban life, waste management is among the primary services provided by municipalities. Our company, offering effective solutions for a clean and orderly environment, provides specialized waste container solutions to support municipalities in their waste management efforts. We offer a wide range of products to facilitate municipal waste collection and management processes. With waste containers available in various sizes, designs, and capacities, we provide solutions tailored to the needs of municipalities. Additionally, our waste container models that contribute to recycling reflect our commitment to an environmentally friendly approach.

Our company's waste containers are made from durable materials, ensuring long-lasting use. These containers are resistant to weather conditions and can be safely used in city parks, streets, squares, and other public areas.

To provide solutions tailored to municipal needs, we have an experienced and expert team. We offer professional support from the project phase through to installation and setup. Additionally, our after-sales services ensure the highest level of customer satisfaction.

Join us in alleviating the challenges of waste management for municipalities and making our cities cleaner and more livable. With our customized solutions, let's make waste management more effective and efficient. Take a step towards a clean future now!

Clean Cities Means Happy People...

Making Our Cities More Livable!



Cleanliness and order are crucial elements that determine the quality of life in our cities. Embracing the vision of clean cities and happy people, we provide solutions to make our cities more livable.



Our customer-focused approach ensures that we offer solutions tailored to each customer's needs. We provide customized waste container solutions for parks, streets, shopping centers, schools, and many other areas.



With our aesthetic and functional designs, we add a modern touch to our cities and help enhance the quality of life. Cleanliness and order are fundamental requirements for people to lead healthy and happy lives. Our waste containers are made from environmentally friendly materials and contribute to keeping cities clean and orderly by providing effective waste collection and recycling services.



Join us in realizing the vision of clean cities and happy people. Our professional team is ready to provide you with the best service in waste management.



A photograph of a park path lined with trees and a modern waste container. The path is paved and leads through a lush green area with many trees. In the foreground, there is a modern, cylindrical waste container with a lid that is slightly open. To the left of the container is a blue and green sign. In the background, there are tall buildings, suggesting an urban park setting.

The Key to Keeping Green Areas Clean

Parks and gardens are areas where residents breathe and relax. Keeping these areas clean and orderly is not only important from an aesthetic perspective but also a part of an environmentally conscious approach.

Our company produces a range of urban furnishing elements for parks and gardens in various sizes and designs. These aesthetically appealing products ensure waste collection without disrupting the natural beauty of parks and gardens. Additionally, our containers, made from durable materials, provide long-lasting use against external factors.

With an environmentally friendly and sustainable approach, our company offers products that contribute to recycling. This helps prevent waste from harming nature and supports the efficient use of resources.

Our waste container solutions, ideal for park and garden management, stand out for their low maintenance requirements. We also offer containers in various colors and designs to suit any aesthetic preference.

If you believe in the importance of keeping your parks and gardens clean, contact us for the right waste container solutions. Our professional team will help you find the best solution tailored to your needs.



Our Vision Is Zero Waste

Environmental awareness is increasing in today's world, and sustainability principles are becoming core priorities for businesses and society. As a company supporting the zero waste vision, we offer eco-friendly and effective solutions in waste management.

Our company produces waste containers designed to play a crucial role in achieving zero waste goals. With containers made from recyclable, renewable, and environmentally friendly materials, we ensure the reduction of waste and promote recycling.

Adopting the zero waste principle, our company strives to minimize environmental impact throughout all processes, from design to production. Our waste containers are known for their durability and long-lasting use, while being made from recyclable materials to ensure waste management without harming nature.

Join us in achieving zero waste goals and protecting our environment. With our customized solutions, let's make waste management more sustainable and effective.



Waste Container

The Top Solution for Those Seeking Durability, Affordability and Urban Aesthetics!

Galvanized waste containers are an ideal solution for eco-friendly and durable waste management. Galvanization is a protective coating formed by zinc plating on a steel surface, which makes the waste containers resistant to rust. With these properties, galvanized waste containers offer long-lasting use and resilience to outdoor conditions.



Galvanized waste containers are an ideal waste management solution for parks, streets, avenues, shopping centers, schools, and many other public areas. As a durable, eco-friendly, and aesthetically pleasing option, galvanized waste containers play a significant role in maintaining cleanliness and order in cities.



Galvanized steel is resistant to outdoor conditions. It withstands sunlight, rain, snow, and other weather elements, which ensures the long-term durability of the containers.



Galvanized waste containers are made from recyclable materials. Additionally, due to their long-lasting nature, they do not need to be replaced frequently, contributing to the efficient use of resources.



Galvanized coating prevents the formation of iron oxide by covering the steel surface with zinc. This feature ensures that the waste containers are long-lasting and durable.



Galvanized waste containers have a modern and stylish appearance. Their clean and shiny surface adds aesthetic value to their surroundings.



Optional Surface



Warning Signs and Labeling



Optional Wheels



Optional Handles



Optional Sizing



Optional Transport Handles



Optional Colors



Custom Design Support

BDB.10120-A



High Corrosion Resistance
Easy to Handle
Lightweight Lid
Impact Resistant
Durable Wheels



94 cm



62 cm



50 cm

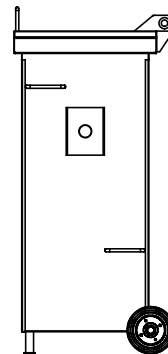
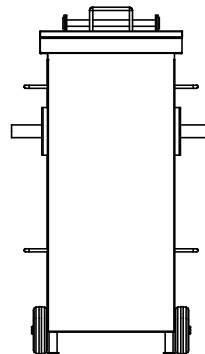
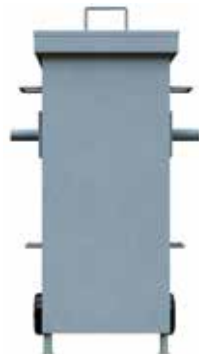

Standard Features



Volume
120lt



Sheet Thickness
Between
1.2/2mm



Certification
EN ISO 1461



Weight
24kg

120 LT Garbage Container

Product Details

- Provides compact and practical waste collection solutions that make daily life easier.
- Ideal for both residential and industrial solid waste with its practical 120-liter capacity.
- Offers high maneuverability even in tight spaces.
- Equipped with a tipping vehicle system-compatible handle, handles for easy maneuvering, and many additional features.

Optional Features

- Alternative color options can be chosen from the RAL catalog.
- Options available for hot-dip galvanizing or electrostatic powder coating.
- Optional lid pedal available from the pedals page.
- Offers custom sheet thickness options tailored to material thickness.
- Allows for visual modifications, corporate identity, or warning signs on the product.
- Provides shipping advantages with the nesting model.
- Custom sizing options are available.

	Standard
	80 Units
	176 Units
	210 Units
	264 Units

BDB.10240-A



High Corrosion Resistance
 Easy to Handle
 Large Capacity, Easy to Transport
 Lightweight Lid
 Impact Resistant
 Durable Wheels



94 cm



68 cm



55 cm

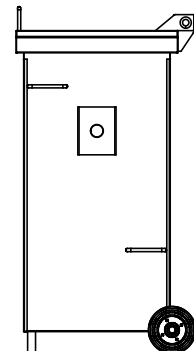
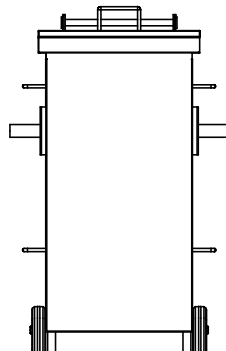
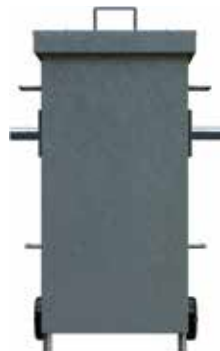

Standard Features



Volume
240lt



Sheet Thickness
Between
1.2/2mm



Certification
EN ISO 1461



Weight
28kg

240 LT Garbage Container

Product Details

- Provides compact and practical waste collection solutions that make daily life easier.
- Ideal for both residential and industrial solid waste with its practical 240-liter capacity.
- Offers high maneuverability even in tight spaces.
- Equipped with a tipping vehicle system-compatible handle, handles for easy maneuvering, and many additional features.

Optional Features

- Alternative color options can be chosen from the RAL catalog.
- Options available for hot-dip galvanizing or electrostatic powder coating.
- Optional lid pedal available from the pedals page.
- Offers custom sheet thickness options tailored to material thickness.
- Allows for visual modifications, corporate identity, or warning signs on the product.
- Provides shipping advantages with the nesting model.
- Custom sizing options are available.

	Standard
	80 Units
	152 Units
	190 Units
	236 Units

BDB.10400-A



High Corrosion Resistance
Easy Vehicle Loading
Lightweight Lid
Impact Resistant
Durable Wheels
Mountable
For Tight Spaces

Standard Features



Volume
400lt



Sheet Thickness
Between
1.2/2mm



Certification
EN ISO 1461



Weight
53-63kg

400 LT Garbage Container

Product Details

- Provides compact and practical waste collection solutions that make daily life easier.
- Ideal for both residential and industrial solid waste with its practical 400-liter capacity.
- Thanks to its swivel wheels, it offers high maneuverability even in tight spaces.
- The braking wheel system provides full balance and safety.
- The handle system is compatible with tipping vehicle systems and is equipped with handles for easy maneuvering and many additional features.

Optional Features

- Alternative color options can be chosen from the RAL catalog.
- Options available for hot-dip galvanizing or electrostatic powder coating.
- From the Covers page, you can select a cover suitable for the product.
- There is an optional cover pedal option from the Pedals page.
- Optional wheels can be selected from the wheels page.
- Offers custom sheet thickness options tailored to material thickness.
- Allows for visual modifications, corporate identity, or warning signs on the product.
- Provides shipping advantages with the nesting model.
- Custom sizing options are available.



102 cm



90 cm



63 cm

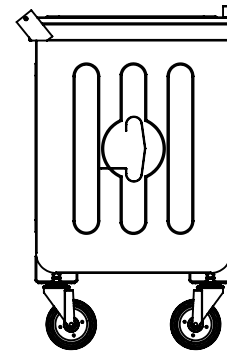
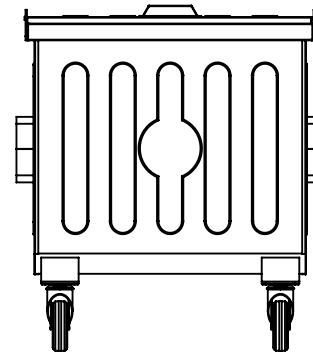

	Standard
	45 Units
	95 Units
	114 Units
	120 Units

BDB.10800-A



+ High Corrosion Resistance
Easy to Handle
Lightweight Lid
Impact Resistant
Durable Wheels

121 cm 115 cm 77 cm



Standard Features



Volume
770lt



Sheet Thickness
Between
1.2/2mm



Certification
EN ISO 1461



Weight
86-101kg

770LT Dump Lid Garbage Container

Product Details

- Provides compact and practical waste collection solutions that make daily life easier.
- Ideal for both residential and industrial solid waste with its practical 770-liter capacity.
- Thanks to its swivel wheels, it offers high maneuverability even in tight spaces.
- The braking wheel system provides full balance and safety.
- Manufactured according to TS EN 840-2 standards.
- The handle system is compatible with tipping vehicle systems and is equipped with handles for easy maneuvering and many additional features.

Optional Features

- Alternative color options can be chosen from the RAL catalog.
- Options available for hot-dip galvanizing or electrostatic powder coating.
- From the Covers page, you can select a cover suitable for the product.
- There is an optional cover pedal option from the Pedals page.
- Optional wheels can be selected from the wheels page.
- Offers custom sheet thickness options tailored to material thickness.
- Allows for visual modifications, corporate identity, or warning signs on the product.
- Provides shipping advantages with the nesting model.
- Custom sizing options are available..

	Standard	Intertwined
	26 Units	48 Units
	56 Units	96 Units
	57 Units	120 Units
	103 Units	130 Units

* The **Intertwined** property represents the ability to nest products.

BDB.11100-A



High Corrosion Resistance
Easy to Handle
Lightweight Lid
Impact Resistant
Durable Wheels

 126 cm
  115 cm
  92 cm



Standard Features



Volume
1100lt



Sheet Thickness
Between
1.2/2mm



Certification
EN ISO 1461



Weight
101-118kg





1100 LT Garbage Container

Product Details

- Provides compact and practical waste collection solutions that make daily life easier.
- Ideal for both residential and industrial solid waste with its practical 1100-liter capacity.
- Thanks to its swivel wheels, it offers high maneuverability even in tight spaces.
- The braking wheel system provides full balance and safety.
- Manufactured according to TS EN 840-2 standards.
- The handle system is compatible with tipping vehicle systems and is equipped with handles for easy maneuvering and many additional features.

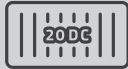
Optional Features

- Alternative color options can be chosen from the RAL catalog.
- Options available for hot-dip galvanizing or electrostatic powder coating.
- From the Covers page, you can select a cover suitable for the product.
- There is an optional cover pedal option from the Pedals page.
- Optional wheels can be selected from the wheels page.
- Offers custom sheet thickness options tailored to material thickness.
- Allows for visual modifications, corporate identity, or warning signs on the product.
- Provides shipping advantages with the nesting model.
- Custom sizing options are available.

	Standard
	18 Units
	39 Units
	42 Units
	94 Units

BDB.11101-A



+ High Corrosion Resistance
Easy to Handle
Lightweight Lid
Impact Resistant
Durable Wheels

Standard Features



Volume
1100lt



Sheet Thickness
Between
1.2/2mm



Certification
EN ISO 1461



Weight
123kg

Dome Lid Garbage Container

Product Details

- Provides compact and practical waste collection solutions that make daily life easier.
- Ideal for both residential and industrial solid waste with its practical 1100-liter capacity.
- Thanks to its swivel wheels, it offers high maneuverability even in tight spaces.
- Manufactured according to TS EN 840-3 standards.
- The handle system is compatible with tipping vehicle systems and is equipped with handles for easy maneuvering and many additional features.

Optional Features



- Alternative color options can be chosen from the RAL catalog.
- Options available for hot-dip galvanizing or electrostatic powder coating.
- From the Covers page, you can select a cover suitable for the product.
- Optional wheels can be selected from the wheels page.
- Offers custom sheet thickness options tailored to material thickness.
- There is a gradual cover system option.
- Allows for visual modifications, corporate identity, or warning signs on the product.
- Custom sizing options are available.

123 cm 145 cm 92 cm













	Standard
	48 Units
	104 Units
	130 Units
	140 Units

GARBAGE CONTAINER LIST

						
Model	Standard	Standard	Standard	Standard	Standard	Dome
Product Code	BDB.10120-A	BDB.10240-A	BDB.10400-A	BDB.10800-A	BDB.11100-A	BDB.11101-A
Width	447 mm	507 mm	909 mm	1155 mm	1155 mm	1230 mm
Height	1074 mm	1074 mm	1021 mm	1217 mm	1265 mm	1456 mm
Depth	497 mm	557 mm	625 mm	770 mm	922 mm	922 mm
Volume	120 lt	240 lt	400 lt	770 lt	1100 lt	1100 lt
Color	<input checked="" type="checkbox"/>	<input checked="" type="checkbox"/>	<input checked="" type="checkbox"/>	<input checked="" type="checkbox"/>	<input checked="" type="checkbox"/>	<input checked="" type="checkbox"/>
Vehicle Lifting	<input checked="" type="checkbox"/>	<input checked="" type="checkbox"/>	<input checked="" type="checkbox"/>	<input checked="" type="checkbox"/>	<input checked="" type="checkbox"/>	<input checked="" type="checkbox"/>
Tilting Handle	<input checked="" type="checkbox"/>	<input checked="" type="checkbox"/>	<input type="checkbox"/>	<input type="checkbox"/>	<input type="checkbox"/>	<input type="checkbox"/>
Wheel	<input checked="" type="checkbox"/>	<input checked="" type="checkbox"/>	<input checked="" type="checkbox"/>	<input checked="" type="checkbox"/>	<input checked="" type="checkbox"/>	<input checked="" type="checkbox"/>
Caster wheel	<input type="checkbox"/>	<input type="checkbox"/>	<input checked="" type="checkbox"/>	<input checked="" type="checkbox"/>	<input checked="" type="checkbox"/>	<input checked="" type="checkbox"/>
Surface	<input checked="" type="checkbox"/>	<input checked="" type="checkbox"/>	<input checked="" type="checkbox"/>	<input checked="" type="checkbox"/>	<input checked="" type="checkbox"/>	<input checked="" type="checkbox"/>
Handle	<input checked="" type="checkbox"/>	<input checked="" type="checkbox"/>	<input checked="" type="checkbox"/>	<input checked="" type="checkbox"/>	<input checked="" type="checkbox"/>	<input checked="" type="checkbox"/>
Warning Sign	<input checked="" type="checkbox"/>	<input checked="" type="checkbox"/>	<input checked="" type="checkbox"/>	<input checked="" type="checkbox"/>	<input checked="" type="checkbox"/>	<input checked="" type="checkbox"/>
Can be nested	<input checked="" type="checkbox"/>	<input checked="" type="checkbox"/>	<input checked="" type="checkbox"/>	<input checked="" type="checkbox"/>	<input checked="" type="checkbox"/>	<input checked="" type="checkbox"/>
Special Size	<input checked="" type="checkbox"/>	<input checked="" type="checkbox"/>	<input checked="" type="checkbox"/>	<input checked="" type="checkbox"/>	<input checked="" type="checkbox"/>	<input checked="" type="checkbox"/>
Lid	<input checked="" type="checkbox"/>	<input checked="" type="checkbox"/>	<input checked="" type="checkbox"/>	<input checked="" type="checkbox"/>	<input checked="" type="checkbox"/>	<input checked="" type="checkbox"/>

Optional Not Available Available

STANDARD RAL CODES

										
RAL	7043	7016	1021	5015	1028	6005	5021	9005	3020	9003

*You can select a stock color from this area.

*Production is carried out in different RAL codes requested.

Additional Info

- Special production containers are not included in this table and are produced specifically for the customer.
- Sheet metal thicknesses can be changed according to customer requests.
- Weight information varies according to optional options. **(If weight is important in your order, please confirm the information with the design team).**
- If the color you want is not among the standard RAL codes, you can select from the Pantone RAL catalog.
- You can customize your product with alternatives such as foil, lexan, reflector, UV printing on the surface.

Optional Not Available Available

LID							
Product Code	Plastic Double Cover	Galvanized Double Cover	Plastic Cover	Pedal Cover	Dome Cover	Dumper Cover	Flat Cover
BDB.10120-A	<input type="checkbox"/>	<input type="checkbox"/>	<input type="checkbox"/>	<input type="checkbox"/>	<input type="checkbox"/>	<input type="checkbox"/>	<input checked="" type="checkbox"/>
BDB.10240-A	<input type="checkbox"/>	<input type="checkbox"/>	<input type="checkbox"/>	<input type="checkbox"/>	<input type="checkbox"/>	<input type="checkbox"/>	<input checked="" type="checkbox"/>
BDB.10400-A	<input type="checkbox"/>	<input type="checkbox"/>	<input type="checkbox"/>	<input checked="" type="checkbox"/>	<input type="checkbox"/>	<input checked="" type="checkbox"/>	<input checked="" type="checkbox"/>
BDB.10800-A	<input type="checkbox"/>	<input type="checkbox"/>	<input checked="" type="checkbox"/>	<input checked="" type="checkbox"/>	<input type="checkbox"/>	<input checked="" type="checkbox"/>	<input checked="" type="checkbox"/>
BDB.11100-A	<input checked="" type="checkbox"/>	<input checked="" type="checkbox"/>	<input checked="" type="checkbox"/>	<input checked="" type="checkbox"/>	<input type="checkbox"/>	<input checked="" type="checkbox"/>	<input checked="" type="checkbox"/>
BDB.11101-A	<input type="checkbox"/>	<input type="checkbox"/>	<input type="checkbox"/>	<input type="checkbox"/>	<input checked="" type="checkbox"/>	<input type="checkbox"/>	<input type="checkbox"/>

*You can customize the product by selecting a cover from this area.

VEHICLE LIFTING						
Product Code	BDB.10120-A	BDB.10240-A	BDB.10400-A	BDB.10800-A	BDB.11100-A	BDB.11101-A
S - Arm	<input checked="" type="checkbox"/>	<input checked="" type="checkbox"/>	<input checked="" type="checkbox"/>	<input checked="" type="checkbox"/>	<input type="checkbox"/>	<input type="checkbox"/>
Euro Arm	<input checked="" type="checkbox"/>	<input checked="" type="checkbox"/>	<input checked="" type="checkbox"/>	<input checked="" type="checkbox"/>	<input checked="" type="checkbox"/>	<input checked="" type="checkbox"/>
Standard Arm	<input type="checkbox"/>	<input type="checkbox"/>	<input checked="" type="checkbox"/>	<input checked="" type="checkbox"/>	<input checked="" type="checkbox"/>	<input checked="" type="checkbox"/>
Guitar Arm	<input checked="" type="checkbox"/>	<input checked="" type="checkbox"/>	<input checked="" type="checkbox"/>	<input checked="" type="checkbox"/>	<input checked="" type="checkbox"/>	<input checked="" type="checkbox"/>

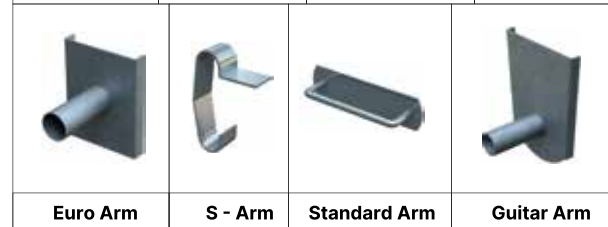

*You can customize the product by selecting the vehicle lift arm from this area.

SURFACE						
Product Code	BDB.10120-A	BDB.10240-A	BDB.10400-A	BDB.10800-A	BDB.11100-A	BDB.11101-A
Hot Dip Galvanizing	<input checked="" type="checkbox"/>	<input checked="" type="checkbox"/>	<input checked="" type="checkbox"/>	<input checked="" type="checkbox"/>	<input checked="" type="checkbox"/>	<input checked="" type="checkbox"/>
Electro Galvanized	<input checked="" type="checkbox"/>	<input checked="" type="checkbox"/>	<input checked="" type="checkbox"/>	<input checked="" type="checkbox"/>	<input checked="" type="checkbox"/>	<input checked="" type="checkbox"/>
Spray Synthetic Paint	<input checked="" type="checkbox"/>	<input checked="" type="checkbox"/>	<input checked="" type="checkbox"/>	<input checked="" type="checkbox"/>	<input checked="" type="checkbox"/>	<input checked="" type="checkbox"/>
Electrostatic Painting	<input checked="" type="checkbox"/>	<input checked="" type="checkbox"/>	<input checked="" type="checkbox"/>	<input checked="" type="checkbox"/>	<input checked="" type="checkbox"/>	<input checked="" type="checkbox"/>

*You can customize the product by selecting the surface from this area.

WHEELS					
Product Code	Break	Portable	Height	Width	Diameter
150'lik	<input checked="" type="checkbox"/>	<input checked="" type="checkbox"/>	192 mm	108 mm	150 mm
160'lik	<input checked="" type="checkbox"/>	<input checked="" type="checkbox"/>	195 mm	140 mm	160 mm
200'lük	<input checked="" type="checkbox"/>	<input checked="" type="checkbox"/>	235 mm	140 mm	200 mm
					
150 Ø	160 Ø		200 Ø		
					
Moblen PP	Fixing				

*You can customize the product by selecting wheels from this area.

*Only the wheel part changes in mobile wheels and can be selected as 150, 160 and 200.

*On fixed wheels, 150, 160 and 200 can be selected.



Above-Ground Waste Container

The Preferred Solution for Those Seeking Durability, Large Capacity, Affordability, and Urban Aesthetics!



Above-ground waste containers are an ideal waste management solution for parks, streets, shopping centers, schools, and many other public spaces. As a durable, eco-friendly, spacious, and aesthetically pleasing option, these containers play a crucial role in maintaining the cleanliness and order of cities.



The above-ground waste container made of galvanized steel is resistant to outdoor conditions. It withstands sunlight, rain, snow, and other weather elements, ensuring the container's longevity and durability in various environments.



Galvanized coating protects the steel surface by covering it with zinc, preventing the metal from oxidizing. This feature ensures that waste containers are long-lasting and durable, even under harsh conditions.



Above-ground waste containers are made from recyclable materials. Additionally, their long-lasting nature means they don't need to be frequently replaced, contributing to the efficient use of resources.



Galvanized waste containers feature a modern and sleek design. Their clean and shiny surface adds an aesthetic touch to their surroundings.



Warning Signs and Labeling



Optional Vehicle Transport



Optional Colors



Optional Sizing



Optional Design Support













Optional Surface

ABOVE GROUND CONTAINER LIST

		
Model	Above Ground	Above Ground
Product Code	BDB.13250-A	BDB.13300-A
Width	1250 mm	1450 mm
Height	1612 mm	1824 mm
Depth	1600 mm	1600 mm
Volume	2500 lt	3000 lt
Color	<input checked="" type="checkbox"/>	<input checked="" type="checkbox"/>
Surface	<input checked="" type="checkbox"/>	<input checked="" type="checkbox"/>
Warning Sign	<input checked="" type="checkbox"/>	<input checked="" type="checkbox"/>

Optional Not Available Available

STANDARD RAL CODES

										
RAL	7043	7016	1021	5015	1028	6005	5021	9005	3020	9003

*You can select a stock color from this area.

*Production is carried out in different RAL codes requested.

SURFACE

	Product Code	BDB.13250-A	BDB.13300-A
Hot Dip Galvanizing		<input checked="" type="checkbox"/>	<input checked="" type="checkbox"/>
Electro Galvanized		<input checked="" type="checkbox"/>	<input checked="" type="checkbox"/>
Spray Synthetic Paint		<input checked="" type="checkbox"/>	<input checked="" type="checkbox"/>
Electrostatic Painting		<input checked="" type="checkbox"/>	<input checked="" type="checkbox"/>

*You can customize the product by selecting the surface from this area.

BDB.12500-A



-  Rust-resistant
- Lightweight lid
- Impact-resistant
- Large capacity
- Pedal-operated

Standard Features



Volume
2500lt



Sheet Thickness
Between
1.2/2mm



Certification
EN ISO 1461

2500 LT Above-Ground Trash Container

Product Information

- Provides compact and practical waste collection solutions that simplify your daily life.
- Ideal for large-scale waste collection operations with its 2500-liter capacity.
- Equipped with a lifting system compatible with crane vehicles and many additional features.

Optional Features

- Alternative color options can be selected from the RAL catalog.
- Choices of hot-dip galvanizing or electrostatic powder coating are available.
- Offers the possibility for visual customization, special design prints, or warning labels on the product.
- Custom sizing options are available.



161 cm



125 cm



160 cm

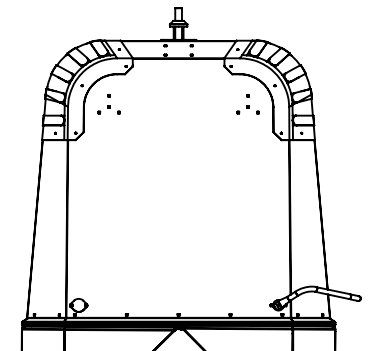
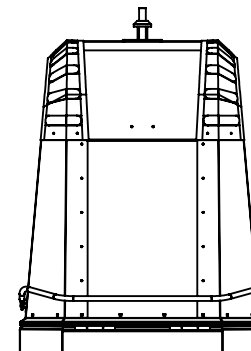

BDB.13000-A



- + Rust-resistant
- Lightweight lid
- Impact-resistant
- Large capacity
- Pedal-operated

Standard Features



Volume
3000lt



Sheet Thickness
Between
1.2/2mm



Certification
EN ISO 1461

3000 LT Above-Ground Trash Container

Product Information

- Provides compact and practical waste collection solutions that simplify your daily life.
- Ideal for large-scale waste collection operations with its 3000-liter capacity.
- Equipped with a lifting system compatible with crane vehicles and many additional features.

Optional Features

- Alternative color options can be selected from the RAL catalog.
- Choices of hot-dip galvanizing or electrostatic powder coating are available.
- Offers the possibility for visual customization, special design prints, or warning labels on the product.
- Custom sizing options are available.



145 cm



182 cm



160 cm

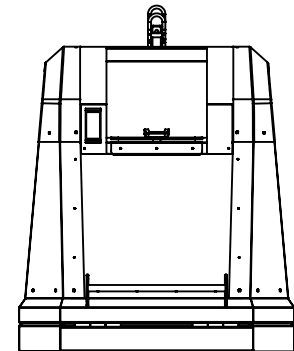
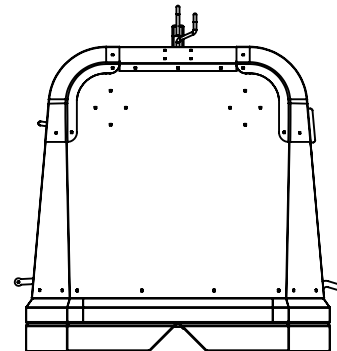



Trash Cans

The Priority Solution for Parks and Gardens!

Your gardens, parks, and sidewalks are the areas where you spend the most time and find peace. Therefore, a clean and organized environment is crucial both aesthetically and for health reasons. Outdoor trash bins are practical and effective solutions that help keep our surroundings clean and organized at all times.



Outdoor trash bins provide a way to collect daily waste, food scraps, and other litter that accumulates in areas such as parks and gardens in an organized manner.



It is resistant to various weather conditions such as rain, snow, and sun; it has rust-resistant and waterproof features.



Buckets made from materials such as steel, durable plastic, or composite offer long-lasting use.



With their natural colors and modern designs, they provide an aesthetically pleasing and environmentally friendly look for parks.



Thanks to their optionally fixed structures, they do not topple due to natural conditions or human intervention, ensuring safe usage.



Optional Surface



Optional Colors



Warning Signs and Labeling



Optional Sizing



Optional Design Support

Metal Series Outdoor

- Produced using gas welding method from steel materials.
- Electrostatic powder coating has been applied to resist rust.
- Can be anchored to the ground.
- Modular design allows for part replacement.

Durable Surfaces
Optional Color Selection
Modular Structure
Impact Resistant
Alternative Surfaces



Electrostatic
Paint



DKP Sheet
Metal Bucket



RAL Colors



BDB.30001-A

Four
Legged
Trash Can



BDB.30002-A

U Type
Trash Can



BDB.30006-A

Cube
Garden Type
Trash Can



BDB.30007-A

Trash Can
with Hat
and Ashtray

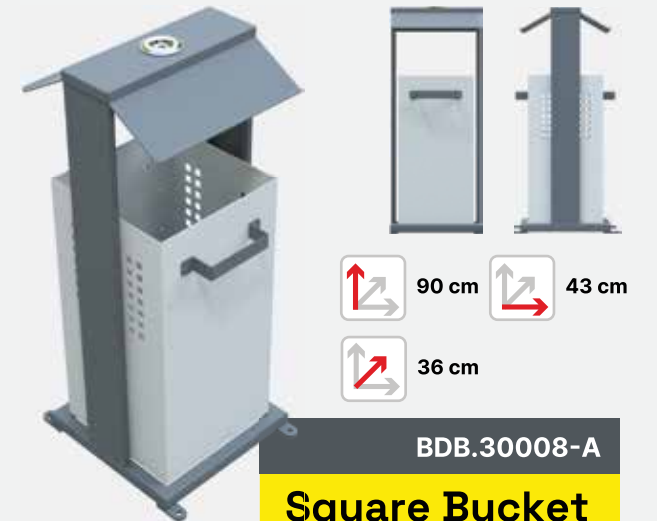

BDB.30008-A

Square Bucket
Ashtray
Trash Can



BDB.30003-A
Trash Can with Profile Legs



BDB.30004-A
Dolphin Type Trash Can

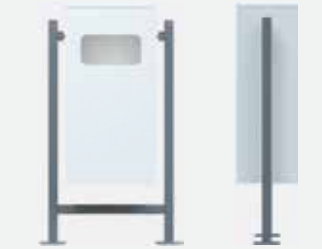

BDB.30005-A
Square Trash Can with Profile Feet



BDB.30009-A
High Ashtray Trash Can



BDB.30010-A
I Type Trash Can



BDB.30011-A
Closed Body Trash Can

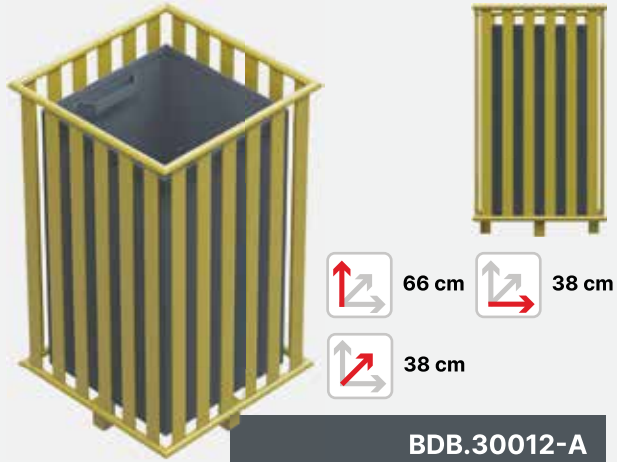

BDB.30012-A

**Profiled Square
Model
Trash Can**

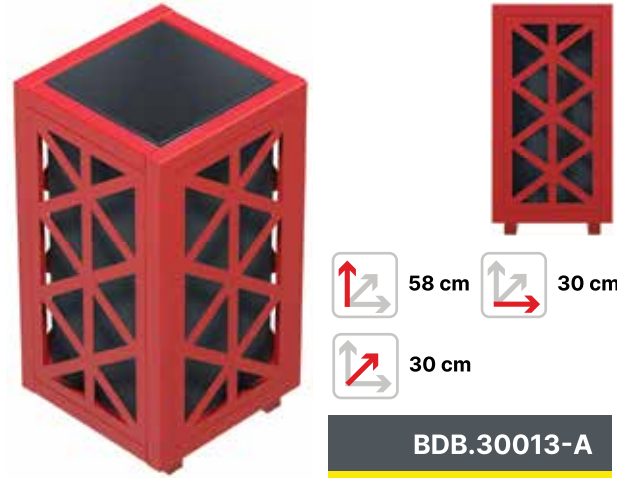

BDB.30013-A

**Decorative
Trash Bin**

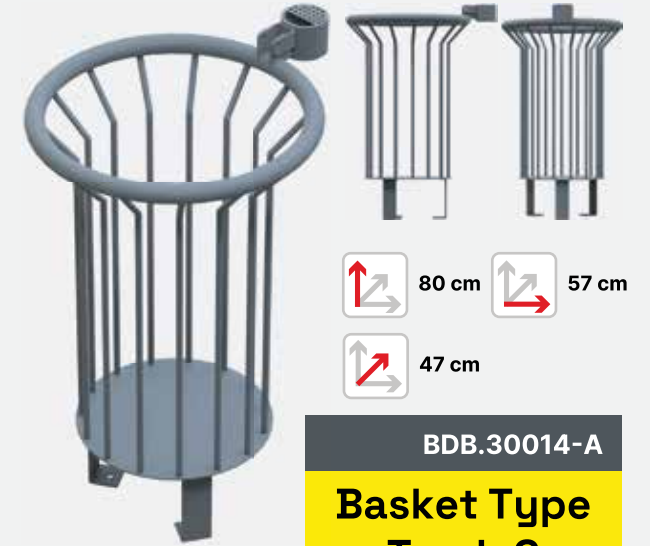

BDB.30014-A

**Basket Type
Trash Can**



BDB.30015-A

**Round
Trash Can**

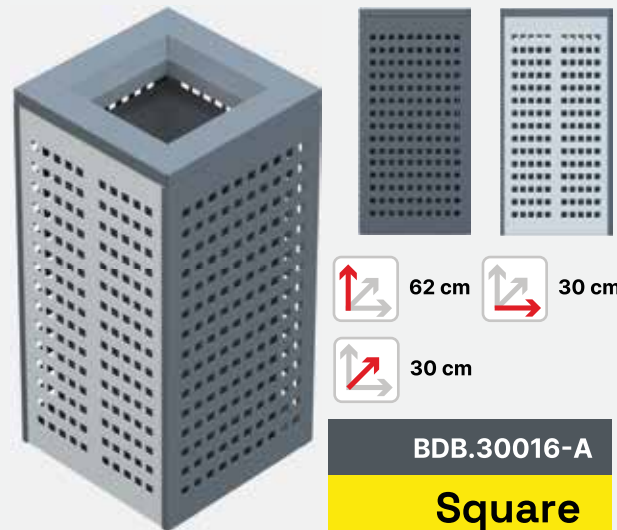

BDB.30016-A

**Square
Patterned
Trash Can**



BDB.30017-A

**Pole Type
Bagged
Trash Can**

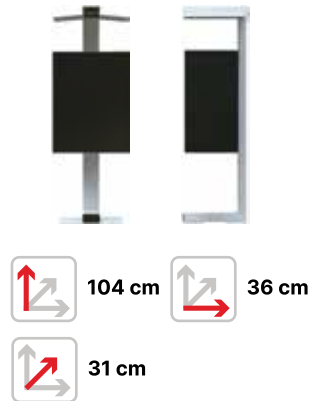

BDB.30018-A
Single Foot Profile Trash Can

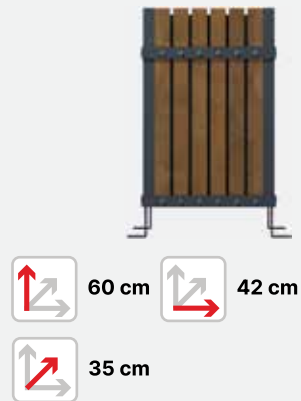

BDB.30101-A
Wooden Square Garden Type Trash Can



BDB.30102-A
Wooden Style Garden Type Trash Can

Wood Series Outdoor

- Made from high-strength steel materials, produced using gas welding techniques.
- Coated with electrostatic powder paint to resist rust.
- Designed for attachment to the ground.
- Features a modular structure, allowing for parts replacement.
- Treated with vacuum impregnation (protects against pests like termites and beetles).
- Available for impregnation in green or brown colors.
- Can be treated with wood stain and varnish.

Durable Surfaces
 Optional Color Selection
 Modular Structure
 Impact Resistant
 Alternative Surfaces
 Alternative Wood



Electrostatic Paint



Impregnated Wood



RAL Colors



BDB.30103-A
Wooden Round Trash Can

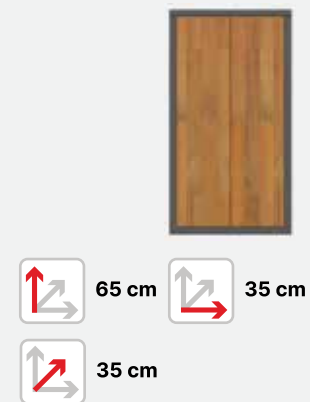

BDB.30104-A
Wooden Cube Trash Can



BDB.30105-A
Wooden Closed Trash Can

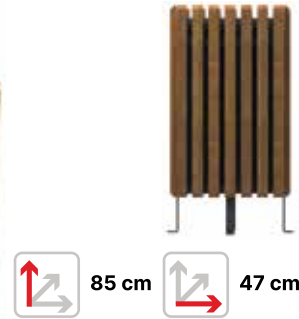

BDB.30106-A
Wooden Fence Model Trash Bin



BDB.30107-A
Seljuk Model Trash Bin



BDB.30109-A
Wooden Portable Trash Can

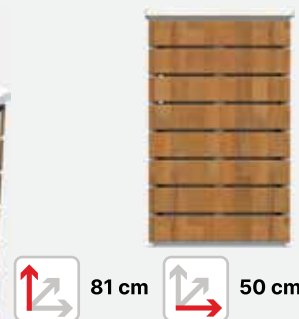

BDB.30110-A
Horizontal Wooden Trash Can

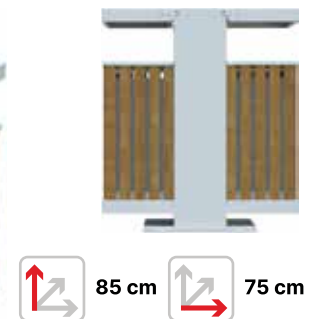

BDB.30111-A
Double Wooden Trash Can



63 cm



42 cm



36 cm

BDB.30108-A

Wooden Ashtray Trash Can



84 cm



51 cm



38 cm

BDB.30112-A

Dome-Top Wooden Trash Bin

STANDARD RAL CODES

RAL	7043	7016	1021	5015	1028	6005	5021	9005	3020	9003

*You can select a stock color from this area.

*Production is carried out in different RAL codes requested.

STANDARD WOODS

	Interior	Outdoor	Thermowood	Emprenye	Varnish
Iroko	Suitable	Suitable	<input checked="" type="checkbox"/>	<input type="checkbox"/>	<input checked="" type="checkbox"/>
Sapelli	Suitable	Suitable	<input type="checkbox"/>	<input type="checkbox"/>	<input checked="" type="checkbox"/>
Okoume	Suitable	Suitable	<input type="checkbox"/>	<input type="checkbox"/>	<input checked="" type="checkbox"/>
Movingui	Suitable	Suitable	<input checked="" type="checkbox"/>	<input type="checkbox"/>	<input checked="" type="checkbox"/>
Pine	Suitable	Suitable	<input checked="" type="checkbox"/>	<input checked="" type="checkbox"/>	<input checked="" type="checkbox"/>

*You can choose the type of wood from this section.

*The woods listed in the table are standard options.

*Production can be done using various types of wood, such as Oak, Beech, and Fir.

Optional Not Available Available

Thermowood

Thermowood is wood that has been subjected to thermal processing in high-insulation, massive ovens at temperatures ranging from 180°C to 220°C. During this process, steam is released into the oven to prevent the wood from cracking. This treatment reduces the moisture content within the wood to near zero and also allows for the release of chemical and harmful substances.

Thermally treated wood is found to experience significantly less warping, cracking, and deformation, allowing it to last much longer in its applications.

Impregnation

The process you're describing is known as wood impregnation or wood preservation. It involves injecting or applying a protective substance to the wood's interior or surface. This treatment enhances the wood's resistance to various harmful factors, thereby extending its lifespan.

Make A Decision for
Clean Parks,
Aesthetic Gardens, and
Comfortable
Living!



City Aesthetics

The Address of Comfort and Elegance in the City

We bring comfort and aesthetics together for parks, gardens, and public spaces, which are indispensable in modern living.



Our benches, produced as urban furniture, are made from the highest quality materials to ensure durability over many years. We offer benches suitable for all weather conditions with our steel and high-quality natural wood options.



With our modern and classic designs that add value to our cities, we provide solutions that fit every space. Our architects and designers work diligently to ensure that each bench is aesthetically pleasing.



We adhere to our sustainability principle by using environmentally friendly materials and respectful production methods. Our benches, made from recyclable materials, are preferred by cities with environmental awareness.



With our ergonomic designs, sitting on our benches is now much more comfortable. Our parks and public spaces will become meeting points for people.



Optional Sizing



Optional Colors



Optional Surface



Custom Design Support



Warning Signs and Labeling

Metal Series Outdoor Benches

- The metal components are weld-free, welded using the gas arc welding method.
- Options for aged paint and electrostatic powder coating are available.
- The wood is treated with vacuum impregnation (protects the product against pests such as termites and beetles).
- Impregnation can be done in green or brown colors.
- Armrests and ground fixing attachments for the benches can be customized according to the customer's request.

Durable Surfaces
Long-Lasting Wood
Impact Resistant
RAL Color Options
Modular Structure
Alternative Surfaces



Electrostatic
Paint



ST37 Sheet Metal
Impregnated Wood



RAL Colors



74 cm



160 cm



50 cm

BDB.40001-A

Standard
Two Way
Bank



84 cm



160 cm



58 cm

BDB.40002 -A

Standard
One Way
Bank

City Aesthetics



60 cm



168 cm



52 cm

BDB.40003-A

Type 0
Double-Way
Bank



87 cm



150 cm



74 cm

BDB.40004-A

Comfort
One Way
Bank



84 cm



160 cm



58 cm

BDB.40005-A

**Oval
One Way
Bank**



82 cm



150 cm



150 cm

BDB.40006-A

**Tale
Two Way
Bank**



46 cm



145 cm



47 cm

BDB.40007-A

**Square
Double
Bench**



86 cm



145 cm



56 cm

BDB.40008-A

**Square
One Way
Bank**



45 cm



145 cm



50 cm

BDB.40009-A

**Profiled
Double
Side Bank**



270 cm



330 cm



200 cm

BDB.410010-A

**Roofed
Picnic Table**



Recycling Series

The Ideal Solution for Recyclable Waste!



Optional Surface



Optional Colors



Warning Signs and Labeling



Optional Sizing



Optional Design Support

Nature is entrusted to all of us. Managing our waste correctly to contribute to nature is a major responsibility for both today and tomorrow. This is where the recycling bins provided by BDB Metal and Defense come into play! With growing environmental awareness and the need for a sustainable future, we all recognize the importance of recycling. Are you ready to explore solutions that make the recycling process easier and more effective?



Elegant and durable recycling bins that blend seamlessly with your modern living spaces. Our products are ideal for both indoor and outdoor use, enhancing your environment with their stylish appearances.









Made from fully recyclable and eco-friendly materials. In our production process, we always prioritize our mission to protect nature. By offering environmentally conscious products, we contribute to reducing the carbon footprint.









Recycling bins feature a modern and stylish design. With their clean and shiny surfaces, they add aesthetic value to their surroundings.



With a variety of color options and categorized designs, you can easily separate your waste. Our bins feature marked compartments for different types of waste, such as organic, paper, plastic, and glass, making recycling more practical than ever.

GROUPING CAGE (For Standard Models)			
			
1 piece	2 piece	3 piece	4 piece
			
5 piece		6 piece	

*Grouping cages in the table are for standard models.

GROUPING CAGE (For Cylinder Models)					
					
1'li	2'li	3'lü	4'lü	5'li	6'li

*Grouping cages in the table are for cylinder models.



*Zero waste label is optional.

LABEL SELECTION					
					
PAPER WASTE	PLASTIC WASTE	GLASS WASTE	METAL WASTE	ORGANIC WASTE	NON-RECYCLABLE WASTES
					

*You can customize your product by selecting a label.

*Your labels can be customized with support from the design team.

**Cylinder
Single Set**



High Corrosion Resistance
Easily Portable
Impact Resistant

BDB.50101-A

**Cylinder Type
Recycling Bin - 1**

24 cm 50 cm

ST37 Sheet Metal
Foil Label

Electrostatic Paint

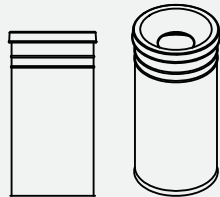

**Cylinder
Single Set**



High Corrosion Resistance
Easily Portable
Impact Resistant

BDB.50102-A

**Cylinder Type
Recycling Bin - 2**

30 cm 50 cm

ST37 Sheet Metal
Foil Label

Electrostatic Paint

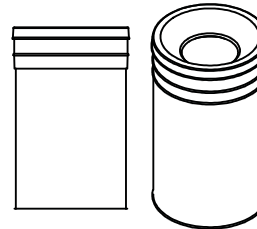

**Cylinder
3-Piece Set**



High Corrosion Resistance
Easily Portable
Impact Resistant

BDB.50103-A

**Cylinder Type Recycling
Bin 1 - 3 Piece Set**

53 cm

30 cm

90 cm

ST37 Sheet Metal
Foil Label

Electrostatic
Paint

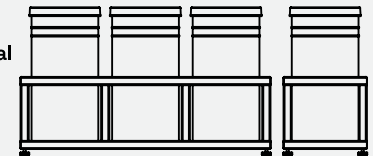
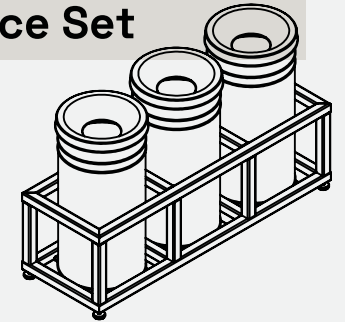

 **Cylinder 3-Piece Set**



High Corrosion Resistance
Easily Portable
Impact Resistant

BDB.50104-A

Cylinder Type Recycling Bin 2 - 3 Piece Set

 53 cm

 35 cm

 115 cm

 ST37 Sheet Metal Foil Label

 Electrostatic Paint

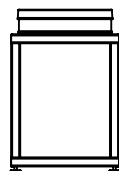
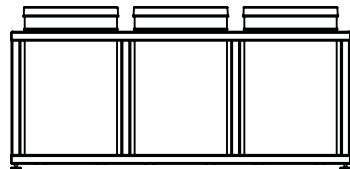
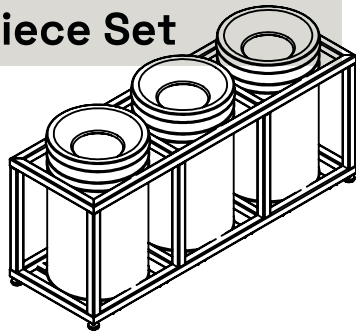

 **Cylinder 4-Piece Set**



High Corrosion Resistance
Easily Portable
Impact Resistant

BDB.50105-A

Cylinder Type RB 1 - 4 Piece Set

 53 cm

 30 cm

 115 cm

 ST37 Sheet Metal Foil Label

 Electrostatic Paint

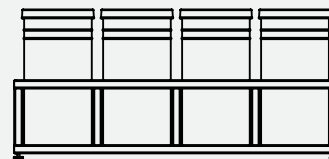
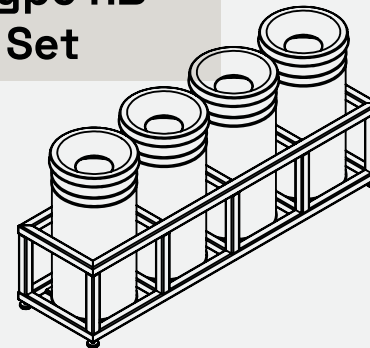

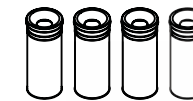
 **Cylinder 4-Piece Set**



High Corrosion Resistance
Easily Portable
Impact Resistant

BDB.50106-A

Cylinder Type RB 2 - 4 Piece Set

 53 cm

 27 cm

 110 cm

 ST37 Sheet Metal Foil Label

 Electrostatic Paint

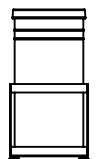
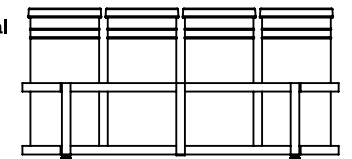
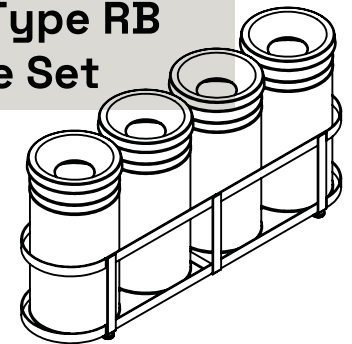

 **Standard Single**



 High Corrosion Resistance
Easily Portable
Impact Resistant

BDB.50107-A
Standard Type Recycling Bin - 1

 36 cm

 68 cm

 36 cm

 ST37 Sheet Metal Foil Label

 Electrostatic Paint

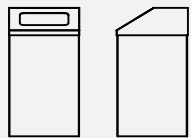
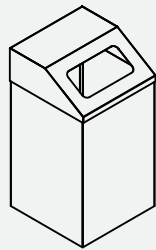

 **Standard Single**



 High Corrosion Resistance
Easily Portable
Impact Resistant

BDB.50108-A
Standard Type Recycling Bin - 2

 25 cm

 68 cm

 25 cm

 ST37 Sheet Metal Foil Label

 Electrostatic Paint

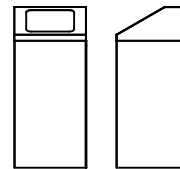
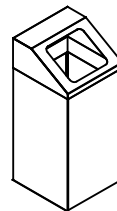

   **Standard 3 Piece Set**



 High Corrosion Resistance
Easily Portable
Impact Resistant

BDB.50109-A
Standard Type RB 1 - 3 Piece Set

 126 cm

 74 cm

 47 cm

 ST37 Sheet Metal Foil Label

 Electrostatic Paint

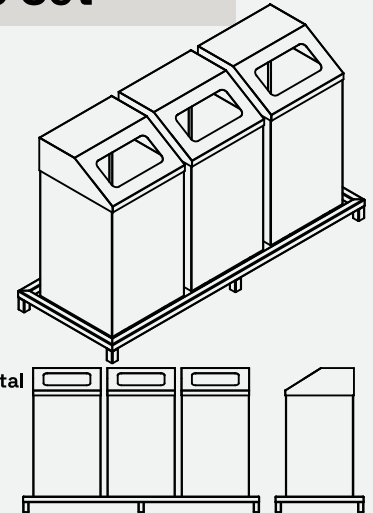

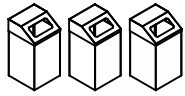

**Standard
3 Piece Set**



High Corrosion Resistance
Easily Portable
Impact Resistant

BDB.50110-A

**Standard Type RB
2 - 3 Piece Set**

102 cm

75 cm

35 cm

ST37 Sheet Metal
Foil Label

Electrostatic
Paint

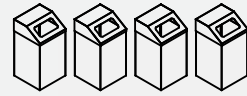
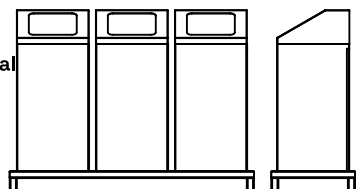
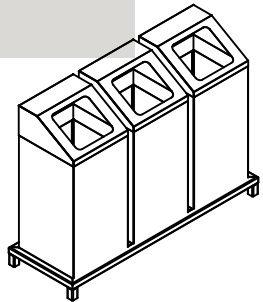

**Standard
4 Piece Set**



High Corrosion Resistance
Easily Portable
Impact Resistant

BDB.50111-A

**Standard Type RB
1 - 4 Piece Set**

165 cm

74 cm

47 cm

ST37 Sheet Metal
Foil Label

Electrostatic
Paint

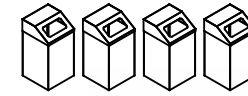
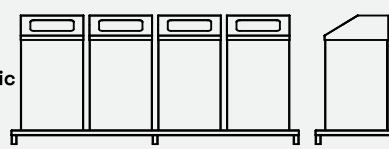
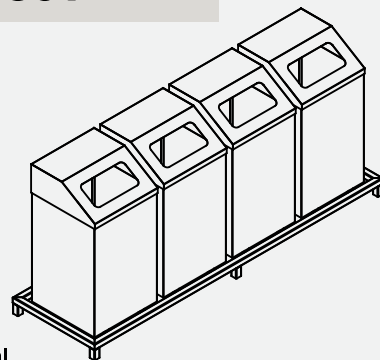

**Standard
4 Piece Set**



High Corrosion Resistance
Easily Portable
Impact Resistant

BDB.50112-A

**Standard Type RB
2 - 3 Piece Set**

120 cm

74 cm

36 cm

ST37 Sheet Metal
Foil Label

Electrostatic
Paint

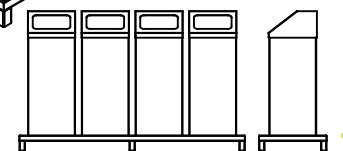
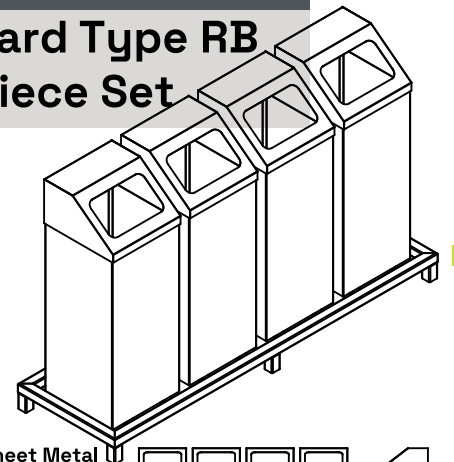





Zero Waste Recycling Bins Series





It's in your hands to protect our environment and promote zero waste awareness for a sustainable future! With the Multi-Bin System, make recycling effortless and practical. Take a step towards leaving a clean world for future generations!

Contribute to a cleaner, greener planet with the Zero Waste Series Multi-Bin System!

-  **Electrostatic Paint**
-  **DKP Sheet Metal Bin**
-  **RAL Colors**





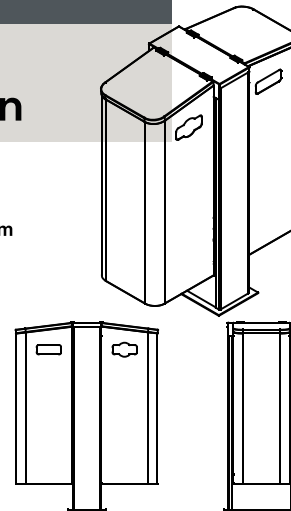

BDB.50113-A Hanging Recycling Bin

-  100 cm  75 cm
-  40 cm
-  **ST37 Sheet Metal Foil Label**
-  **Electrostatic Paint**



BDB.50114-A Cube 4-Layer Recycling Bin - 1

-  83 cm
-  56 cm
-  38 cm
-  **ST37 Sheet Metal Foil Label**
-  **Electrostatic Paint**

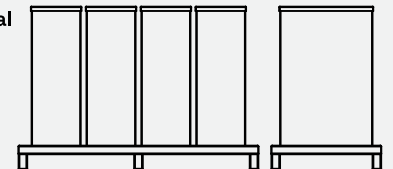
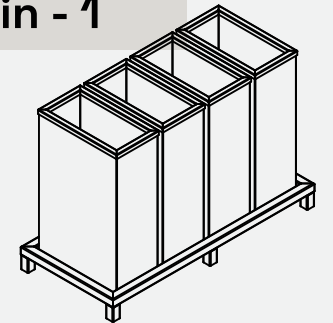



High Corrosion Resistance
Easily Portable
Impact Resistant

BDB.50115-A

Cube 4-Layer Recycling Bin - 2



61 cm



56 cm



61 cm



ST37 Sheet Metal
Foil Label



Electrostatic
Paint

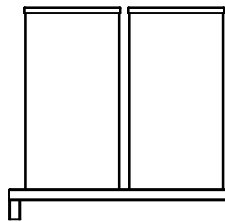
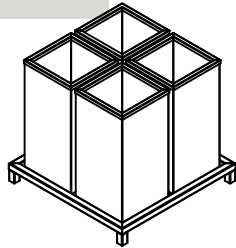

High Corrosion Resistance
Easily Portable
Impact Resistant

BDB.50116-A

Group Recycling Bin - 1



53 cm



30 cm



19 cm



ST37 Sheet Metal
Foil Label



Electrostatic
Paint

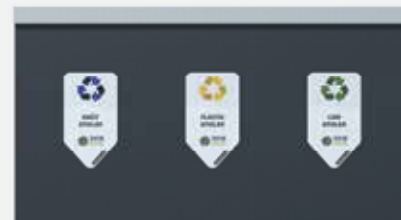
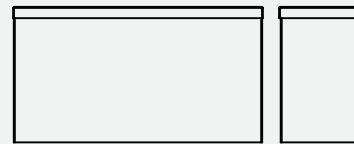
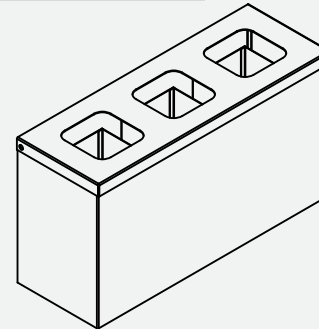

High Corrosion Resistance
Easily Portable
Impact Resistant

BDB.50117-A

Group Recycling Bin - 2



70 cm



60 cm



23 cm



ST37 Sheet Metal
Foil Label



Electrostatic
Paint

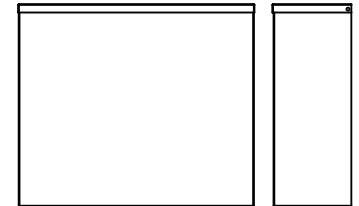
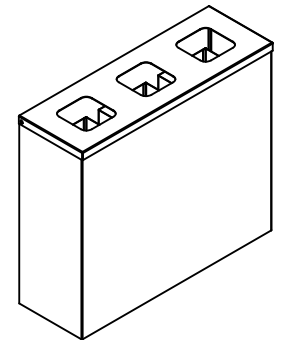

Recycling Bin Moneybox Series

- With bins designed in specific colors for each recycling category, you can easily separate materials such as plastic, glass, paper, and metal.
- Made from durable and eco-friendly materials, these bins not only protect the environment but also facilitate waste management.
- Designed with directional labels and explanations for easy use by everyone.
- Available in various sizes suitable for home, school, office, or public spaces.

Recycling bins allow you to separate your waste at the source and contribute to recycling. Each piece of waste is an investment in the future. Choose recycling bins to protect natural resources and leave a healthy environment for future generations.

Protect the environment and make a difference for the future with Recycling Bins! Let your waste be valued, and make our world more beautiful!

 **Electrostatic Paint**

 **DKP Sheet Metal Bin**

 **RAL Colors**



 High Corrosion Resistance
 Impact Resistant
 High Volume
 Full Cover Label
 Locked Lid



BDB.50201-A
Recycling Bin Moneybox

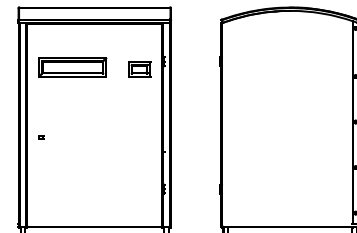

 90 cm  150 cm  90 cm

 **ST37 Sheet Metal Foil Label**  **Electrostatic Paint**



BDB.50202-A
Clothes Bin money box

 100 cm  183 cm  80 cm

 **ST37 Sheet Metal Foil Label**  **Electrostatic Paint**

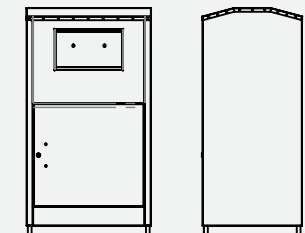

! Metal or Plastic Garbage Container Inside is Optional



90 cm

200 cm

90 cm

BDB.50203-A

Waste Collection Center with Basketball Hoop

Mobile Waste Collection Series

- With bins designed in special colors for each recycling category, you can easily separate materials such as plastic, glass, paper, and metal.



Electrostatic Paint



RAL Colors



High Corrosion Resistance
Impact Resistant



420 cm

180 cm

190 cm

BDB.50301-A

Compartment Mobile Waste Collection Center 7 Units



180 cm

170 cm

82 cm

BDB.50204-A

Heart Themed Waste Collection Center



110 cm

120 cm

61 cm

BDB.50205-A

70LT 2-Unit-Compartment Corrugated Bin



250 cm

200 cm

145 cm

BDB.50301-A

Compartment Mobile Waste Collection Center 6 Units

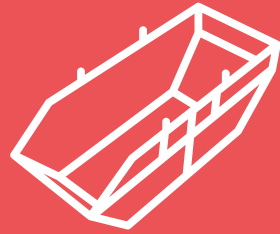

Rubble Container

High Quality Solution for High Volume Seekers

In construction, renovation, gardening, or industrial projects, accumulated debris and waste can make your work areas cluttered and hazardous. That's where we come in! With our professional debris container services, we ensure your projects proceed smoothly and cleanly.



We enhance job safety by ensuring debris and waste are collected in an organized manner, making your work areas more orderly.



We save you time and reduce costs by handling the collection and disposal of waste.



We provide environmentally friendly services using sustainable waste management and recycling methods.



We facilitate the rapid and efficient collection of construction waste such as concrete, stone, bricks, and other materials based on the size and needs of your projects.



We collect debris, furniture pieces, and old flooring and wall coverings after renovation work in your home or workplace, helping you quickly restore your living space to its original state.



We handle plant waste, soil, grass, and other natural debris generated during garden or landscaping projects, keeping your garden clean and organized.



We collect heavy and voluminous industrial waste from factories and production facilities, offering tailored solutions to simplify industrial waste management.



Warning Signs and Labeling



Optional Sizing



Optional Design Support



Optional Surface



Optional Colors



Rubble Container

- Designed for the collection and storage of solid waste.
- Special painting applications have been used to improve corrosion resistance.
- Reinforced with supports and ribs for increased strength.
- Designed to be compatible with lifting equipment.
- Nested model option available for easy storage and shipping.
- Color selection can be made from the RAL catalog.
- Available in both lid and no-lid models.
- Sheet thickness can vary based on customer requirements.
- Custom sizes can be produced.

High Corrosion Resistance
Portable
Impact Resistant



Rubble Container

-  Electrostatic Paint
-  Foil Label
-  Ral Colors



Certification
EN ISO 1461

BDB.60102-A

2 M³ Rubble Container



-  2 m³
-  116 cm
-  152 cm
-  184 cm

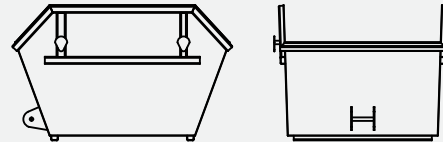

BDB.60103-A

3 M³ Rubble Container





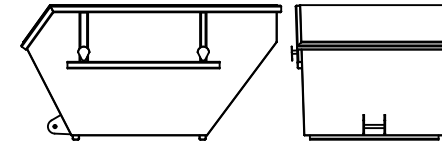

-  3 m³
-  120 cm
-  151 cm
-  233 cm



BDB.60104-A

4 M³ Rubble Container



-  4 m³
-  235 cm
-  125 cm
-  172 cm

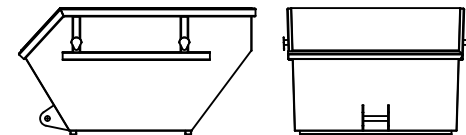

BDB.60105-A

5,5 M³ Rubble Container

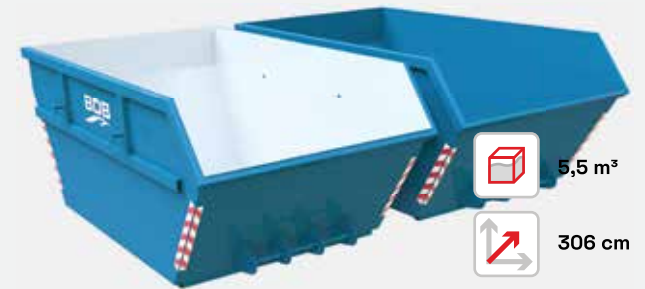

-  5,5 m³
-  306 cm
-  129 cm
-  196 cm

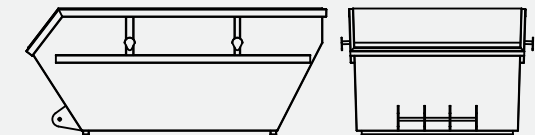

7 M³ Rubble Container

BDB.60107-A

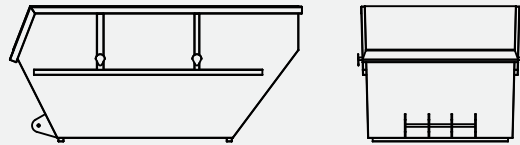

-  7 m³
-  150 cm
-  187 cm
-  332 cm

8 M³ Rubble Container

BDB.60108-A

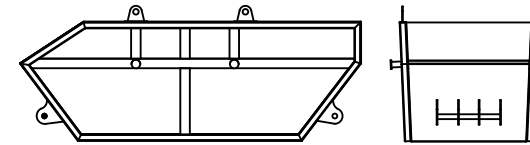

-  8 m³
-  150 cm
-  174 cm
-  430 cm

10 M³ Rubble Container

BDB.60110-A

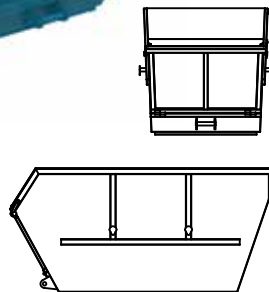











-  10 m³
-  184 cm
-  192 cm
-  381 cm



All debris containers are available in sizes with no lid, single lid, and double lid options.

STANDARD RAL CODES

										
RAL	7043	7016	1021	5015	1028	6005	5021	9005	3020	9003

*You can select a stock color from this area.

*Production is carried out in different RAL codes requested.



Vehicle Bodies

The Solution for Those Seeking Quality and Volume in Garbage Truck Bodies

The cleanliness and order of cities are crucial for the sustainability of modern living. As a company, we produce the most durable and efficient garbage truck bodies for municipalities and private cleaning companies that take on this important task. With years of experience and technical knowledge, we contribute to keeping your cities clean and organized.



We produce high-quality and durable garbage truck bodies. With our wide range of products and custom production options, we offer the most suitable solutions for municipalities and private cleaning companies.



Our garbage truck bodies ensure that waste collection operations are completed with fewer trips by providing maximum carrying capacity. This helps save both time and fuel.



Each garbage truck body is meticulously manufactured to high standards using modern and innovative production techniques. We perform quality control tests at every stage of the production process to provide you with the most reliable products.



By using the highest quality materials in our garbage truck bodies, we offer long-lasting and durable products. Our bodies, produced with high-strength steel and special alloys, perform exceptionally even in the toughest conditions.



Optional Surface



Warning Signs and Labeling



Optional Colors



Optional Sizing



Custom Design Support

Product Features

- Designed for the collection and transportation of waste.
- Features a hydraulic system for waste compaction.
- Equipped with a tipping mechanism.
- Manufactured from Hardox and ST-52 materials.



Certification
EN ISO 1461

**Wear-Resistant
Compatibility with Various Equipment
Dumping and Compaction Feature
Impact-Resistant**



With our environmentally friendly production processes, we fulfill our responsibility to protect nature. By using recyclable materials and focusing on energy efficiency, we contribute to a sustainable future.



With our flexible production capacity tailored to the size and specifics of your projects, we can quickly and effectively respond to all demands.



Our products enhance waste management processes, contributing to the cleanliness and health of cities. We provide eco-friendly solutions with designs that comply with modern waste management standards.



BDB.60208-A **8 M³**
Garbage
Truck
Body

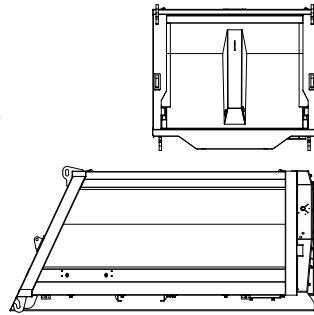

 179 cm  210 cm  307 cm  8 m³



BDB.60216-A **16 M³**
Garbage
Truck
Body

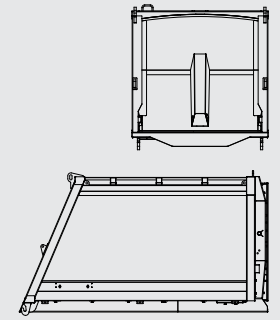

 242 cm  330 cm  243 cm  16 m³



BDB.60209-A **9 M³**
Garbage
Truck
Body

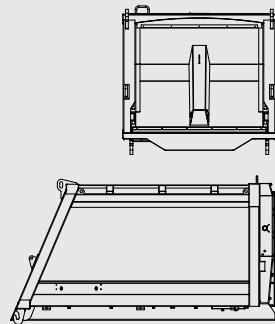

 196 cm  219 cm  296 cm  9 m³



BDB.60222-A **22 M³**
Garbage
Truck
Body

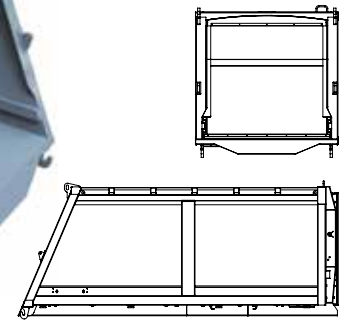

 242 cm  600 cm  243 cm  22 m³

SURFACE						
Product Code	BDB.10120-A	BDB.10240-A	BDB.10400-A	BDB.10800-A	BDB.11100-A	BDB.11101-A
Hot Dip Galvanizing	★	★	★	★	★	★
Electro Galvanized	☑	☑	☑	☑	☑	☑
Spray Synthetic Paint	★	★	★	★	★	★
Electrostatic Painting	★	★	★	★	★	★

*You can customize the product by selecting the surface from this area.

LABEL SELECTION

*You can customize your product by selecting a label.

*Your labels can be customized with support from the design team.

STANDARD WOODS					
	Interior	Outdoor	Thermowood	Emprenye	Varnish
Iroko	Suitable	Suitable	★	☐	★
Sapelli	Suitable	Suitable	☐	☐	★
Okoume	Suitable	Suitable	☐	☐	★
Movingui	Suitable	Suitable	★	☐	★
Pine	Suitable	Suitable	★	★	★

*You can choose the type of wood from this section.

*The woods listed in the table are standard options.

*Production can be done using various types of wood, such as Oak, Beech, and Fir.

STANDARD RAL CODES										
	RAL 7043	7016	1021	5015	1028	6005	5021	9005	3020	9003
	■	■	■	■	■	■	■	■	■	■

*You can select a stock color from this area.

*Production is carried out in different RAL codes requested.

Optional ★ Not Available ☐ Available ☑

Nature Is In Our Hands

Nature is our most precious treasure. With every breath we take, every sip of water we drink, and every sunrise we greet, it offers us the gift of life. But this gift can slip away from us if not protected.

Our daily actions and choices shape the future of nature. Plastic waste, unnecessary energy consumption, habits that destroy forests—nature didn't ask us to do these things; we chose them. Yet, there is still time to make the right choices and save the future.

Give recycling a chance. Use your energy efficiently. Protect natural resources. Nature is not just a resource; it is the foundation on which we build our future. Protecting nature is in our hands. Our choices will determine the legacy we leave for our children.

Remember, nature is not just for us. Future generations also have a right to this world. If we want to leave them a green world, clean air, and clear water, we must act today. Because nature is in our hands, and protecting it is each of our responsibilities.

**Take care of nature, take care of the future.
Because nature is in our hands!**





info@bdbmetal.com

444 7 909

Main Building

Bahçelievler Mah.
570. Cadde, No: 13
Hasanoğlan /
Elmadağ / ANKARA

Second Factory

Bahçelievler Mah.
599. Cadde, No: 18
Hasanoğlan /
Elmadağ / ANKARA

Marmara Office

Beylikdüzü OSB Mah.,
Birlik Sanayi Sitesi,
3. Cadde No:139
Beylikdüzü/İSTANBUL



The burden of the
entire city...

www.bdbmetal.com 